

## Description

The 5.0SMDJ-Q series is designed specifically to protect sensitive electronic equipment from voltage transients induced by lightning and other transient voltage events. For surface mounted applications in order to optimize board space.

## Features

- Halogen free and RoHS compliant
- Low profile package
- Built-in strain relief design
- Low inductance
- Excellent clamping capability
- 5000W peak pulse power capability at 10/1000 $\mu$ s waveform, repetition rate (duty cycle): 0.01%
- Fast response time
- Typical  $I_R$  less than 2 $\mu$ A above 22V devices
- Peak 260 $^{\circ}$ C high temperature Reflow Soldering withstanding
- Meet MSL level1, per J-STD-020
- IEC-61000-4-2 ESD 30kV(Air), 30kV (Contact)
- Unit Weight: 0.30g
- AEC-Q101 Qualified

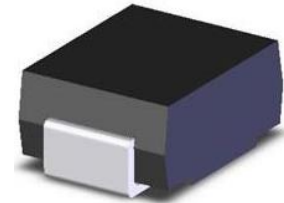

## Applications

TVS components are ideal for the protection of I/O Interfaces, VCC bus and other vulnerable circuits used in telecom, computer, Industrial and consumer electronic applications.

## Maximum Ratings and Characteristics ( $T_A=25^{\circ}\text{C}$ )

Rating	Symbol	Value
Peak pulse power dissipation at 10/1000 $\mu$ s waveform (Note1, Note2, Fig.1)	$P_{PPM}$	5000W
Peak pulse current of at 10/1000 $\mu$ s waveform (Note 1, Fig.3)	$I_{PPM}$	See Table(A)
Steady state power dissipation at $T_A=50^{\circ}\text{C}$ (Fig.5)	$P_{M(AV)}$	6.5W
Maximum Instantaneous Forward Voltage at 100A for Unidirectional Only	$V_F$	3.5V/5.0V
Peak forward surge current, 8.3ms single half sine-wave superimposed on rated load, (JEDEC Method) (Note3, Fig.6)	$I_{FSM}$	300A
Operating junction and Storage Temperature Ranges	$T_J, T_{STG}$	-55 $^{\circ}\text{C}$ to +150 $^{\circ}\text{C}$
Typical thermal resistance junction to lead	$R_{\theta JL}$	15 $^{\circ}\text{C}/\text{W}$
Typical thermal resistance junction to ambient	$R_{\theta JA}$	75 $^{\circ}\text{C}/\text{W}$

Notes:1. Non-repetitive current pulse, per Fig.3 and derating above  $T_A=25^{\circ}\text{C}$  per Fig.2.

2. Each terminal is surface Mounted on the 8.0mm $\times$ 8.0mm copper pads.

3. 8.3ms single half sine-wave or equivalent square wave, duty cycle=4 pulses per minutes maximum.

4.  $V_F < 3.5\text{V}$  for single die parts and  $V_F < 5.0\text{V}$  for stacked-die parts.

**Electrical Characteristics (T<sub>A</sub>=25°C)**

Part Number		Device Marking Code		Reverse Stand-Off Voltage	Breakdown Voltage @I <sub>T</sub>		Test Current	Maximum Clamping Voltage @I <sub>PP</sub>	Peak Pulse Current	Reverse Leakage @V <sub>R</sub>
Uni.	Bi.	Uni.	Bi.	V <sub>R</sub> (V)	V <sub>B Min.</sub> (V)	V <sub>B Max.</sub> (V)	I <sub>T</sub> (mA)	V <sub>C</sub> (V)	I <sub>PP</sub> (A)	I <sub>R</sub> (μA)
5.0SMDJ11A-Q	5.0SMDJ11CA-Q	5PEN	5BEN	11.0	12.20	13.50	10	18.2	275.0	800
5.0SMDJ12A-Q	5.0SMDJ12CA-Q	5PEP	5BEP	12.0	13.30	14.70	10	19.9	252.0	800
5.0SMDJ13A-Q	5.0SMDJ13CA-Q	5PEQ	5BEQ	13.0	14.40	15.90	10	21.5	233.0	500
5.0SMDJ14A-Q	5.0SMDJ14CA-Q	5PER	5BER	14.0	15.60	17.20	10	23.2	216.0	200
5.0SMDJ15A-Q	5.0SMDJ15CA-Q	5PES	5BES	15.0	16.70	18.50	1	24.4	205.0	100
5.0SMDJ16A-Q	5.0SMDJ16CA-Q	5PET	5BET	16.0	17.80	19.70	1	26.0	193.0	50
5.0SMDJ17A-Q	5.0SMDJ17CA-Q	5PEU	5BEU	17.0	18.90	20.90	1	27.6	181.0	20
5.0SMDJ18A-Q	5.0SMDJ18CA-Q	5PEV	5BEV	18.0	20.00	22.10	1	29.2	172.0	10
5.0SMDJ20A-Q	5.0SMDJ20CA-Q	5PEW	5BEW	20.0	22.20	24.50	1	32.4	155.0	5
5.0SMDJ22A-Q	5.0SMDJ22CA-Q	5PEX	5BEX	22.0	24.40	26.90	1	35.5	141.0	5
5.0SMDJ24A-Q	5.0SMDJ24CA-Q	5PEZ	5BEZ	24.0	26.70	29.50	1	38.9	129.0	2
5.0SMDJ26A-Q	5.0SMDJ26CA-Q	5PFE	5BFE	26.0	28.90	31.90	1	42.1	119.0	2
5.0SMDJ28A-Q	5.0SMDJ28CA-Q	5PFG	5BFG	28.0	31.10	34.40	1	45.4	110.0	2
5.0SMDJ30A-Q	5.0SMDJ30CA-Q	5PFK	5BFK	30.0	33.30	36.80	1	48.4	103.0	2
5.0SMDJ33A-Q	5.0SMDJ33CA-Q	5PFM	5BFM	33.0	36.7	40.6	1	53.3	93.9	2
5.0SMDJ36A-Q	5.0SMDJ36CA-Q	5PFP	5BFP	36.0	40.0	44.2	1	58.1	86.1	2
5.0SMDJ40A-Q	5.0SMDJ40CA-Q	5PFR	5BFR	40.0	44.4	49.1	1	64.5	77.6	2
5.0SMDJ43A-Q	5.0SMDJ43CA-Q	5PFT	5BFT	43.0	47.8	52.8	1	69.4	72.1	2
5.0SMDJ45A-Q	5.0SMDJ45CA-Q	5PFV	5BFV	45.0	50.0	55.3	1	72.7	68.8	2
5.0SMDJ48A-Q	5.0SMDJ48CA-Q	5PFX	5BFX	48.0	53.3	58.9	1	77.4	64.7	2
5.0SMDJ51A-Q	5.0SMDJ51CA-Q	5PFZ	5BFZ	51.0	56.7	62.7	1	82.4	60.7	2
5.0SMDJ54A-Q	5.0SMDJ54CA-Q	5PGE	5BGE	54.0	60.0	66.3	1	87.1	57.5	2
5.0SMDJ58A-Q	5.0SMDJ58CA-Q	5PGG	5BGG	58.0	64.4	71.2	1	93.6	53.5	2
5.0SMDJ60A-Q	5.0SMDJ60CA-Q	5PGK	5BGK	60.0	66.7	73.7	1	96.8	51.7	2
5.0SMDJ64A-Q	5.0SMDJ64CA-Q	5PGM	5BGM	64.0	71.1	78.6	1	103.0	48.6	2

**Electrical Characteristics (T<sub>A</sub>=25°C)**

Part Number		Device Marking Code		Reverse Stand-Off Voltage	Breakdown Voltage @I <sub>T</sub>		Test Current	Maximum Clamping Voltage @I <sub>PP</sub>	Peak Pulse Current	Reverse Leakage @V <sub>R</sub>
Uni.	Bi.	Uni.	Bi.	V <sub>R</sub> (V)	V <sub>B Min.</sub> (V)	V <sub>B Max.</sub> (V)	I <sub>T</sub> (mA)	V <sub>C</sub> (V)	I <sub>PP</sub> (A)	I <sub>R</sub> (μA)
5.0SMDJ70A-Q	5.0SMDJ70CA-Q	5PGP	5BGP	70.0	77.8	86.0	1	113.0	44.3	2
5.0SMDJ75A-Q	5.0SMDJ75CA-Q	5PGR	5BGR	75.0	83.3	92.1	1	121.0	41.4	2
5.0SMDJ78A-Q	5.0SMDJ78CA-Q	5PGT	5BGT	78.0	86.7	95.8	1	126.0	39.7	2
5.0SMDJ85A-Q	5.0SMDJ85CA-Q	5PGV	5BGV	85.0	94.4	104.0	1	137.0	36.5	2
5.0SMDJ90A-Q	5.0SMDJ90CA-Q	5PGX	5BGX	90.0	100.0	111.0	1	146.0	34.3	2
5.0SMDJ100A-Q	5.0SMDJ100CA-Q	5PGZ	5BGZ	100.0	111.0	123.0	1	162.0	30.9	2
5.0SMDJ110A-Q	5.0SMDJ110CA-Q	5PHE	5BHE	110.0	122.0	135.0	1	177.0	28.3	2
5.0SMDJ120A-Q	5.0SMDJ120CA-Q	5PHG	5BHG	120.0	133.0	147.0	1	193.0	26.0	2
5.0SMDJ130A-Q	5.0SMDJ130CA-Q	5PHK	5BHK	130.0	144.0	159.0	1	209.0	24.0	2
5.0SMDJ150A-Q	5.0SMDJ150CA-Q	5PHM	5BHM	150.0	167.0	185.0	1	243.0	20.6	2
5.0SMDJ160A-Q	5.0SMDJ160CA-Q	5PHP	5BHP	160.0	178.0	197.0	1	259.0	19.3	2
5.0SMDJ170A-Q	5.0SMDJ170CA-Q	5PHR	5BHR	170.0	189.0	209.0	1	275.0	18.2	2

Ratings and Characteristic Curves ( $T_A=25^\circ\text{C}$ )

Figure 1. Peak Pulse Power Rating Curve

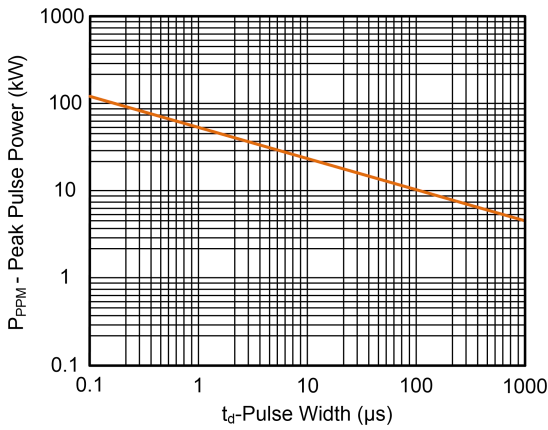

Figure 2. Pulse Derating Curve

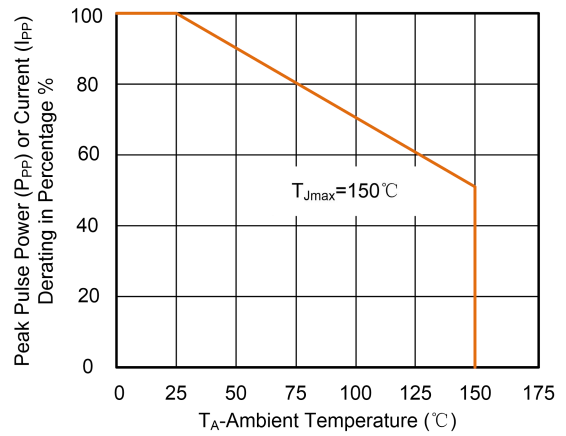

Figure 3. Pulse Waveform

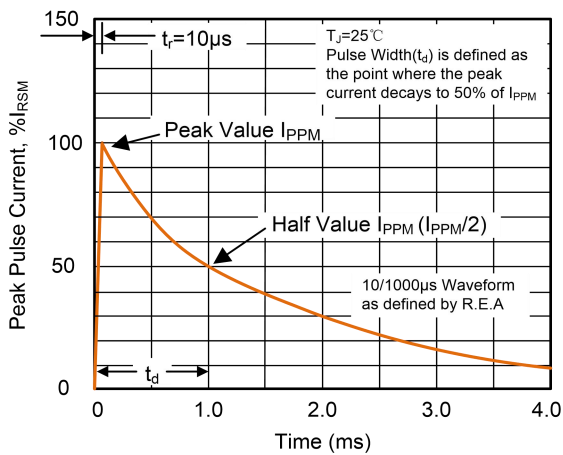

Figure 4. Typical Junction Capacitance

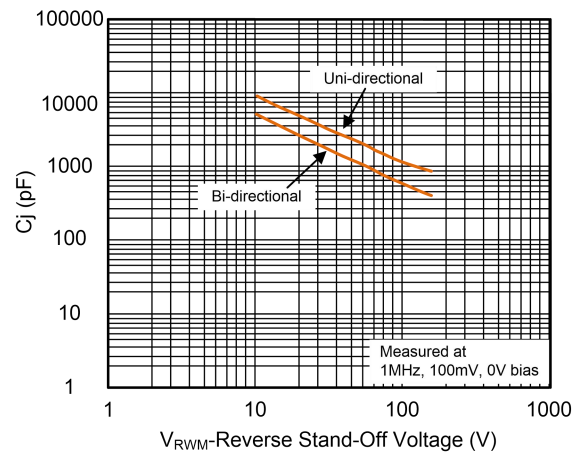

Figure 5. Steady State Power Dissipation Derating Curve

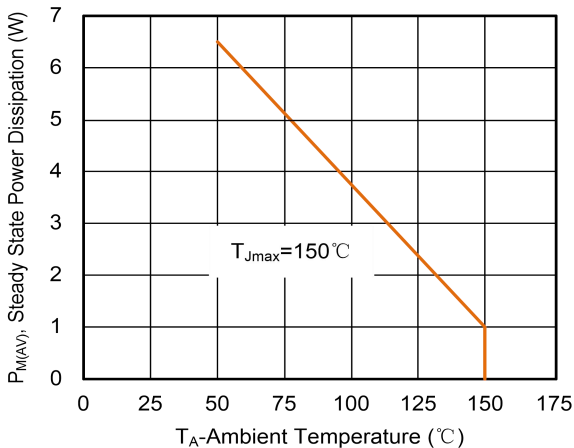
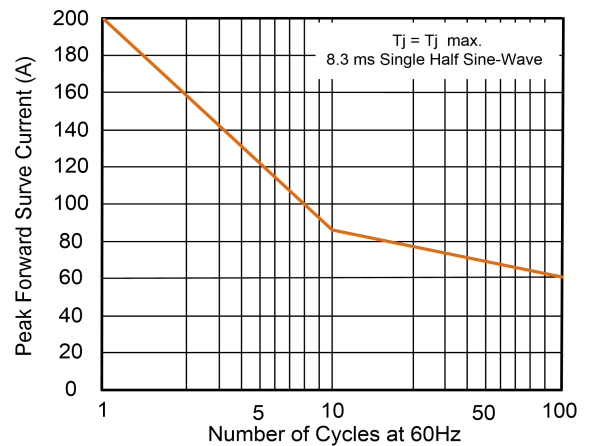
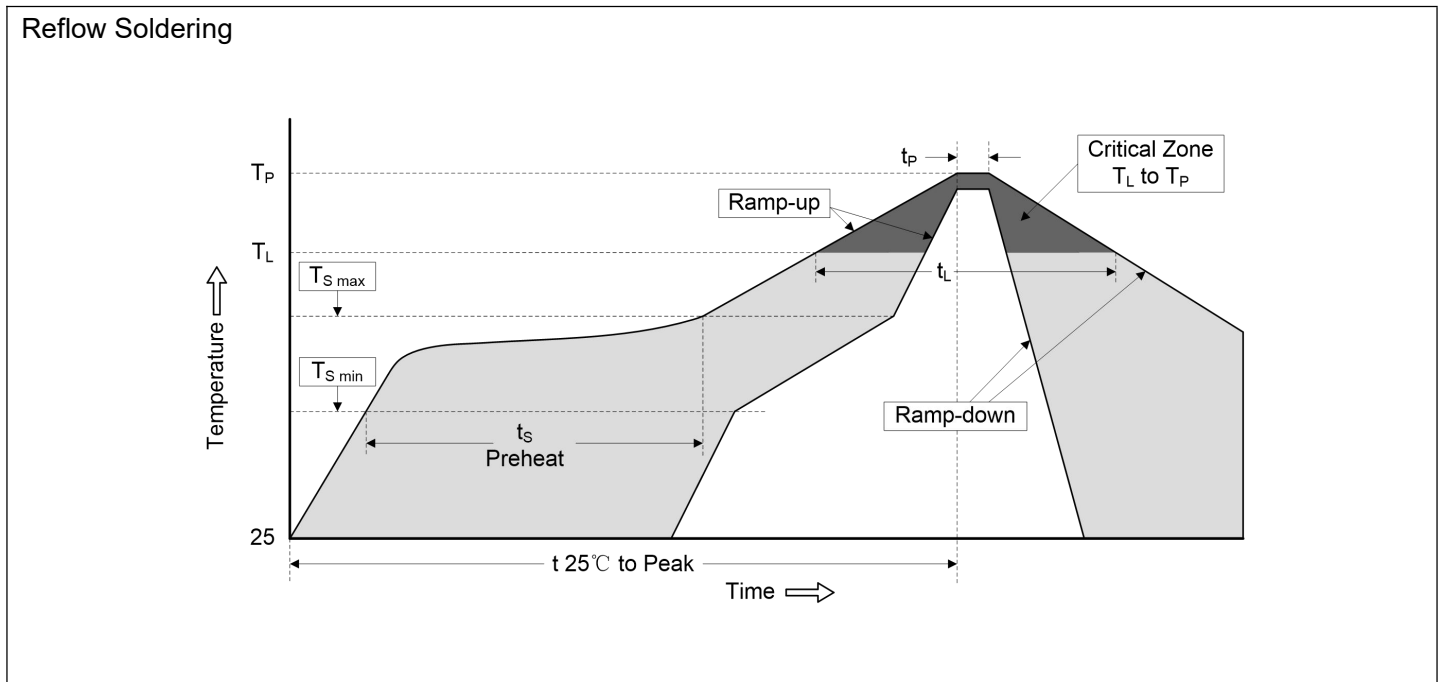

Figure 6. Maximum Non-Repetitive Forward Surge Current Uni-Directional Only



## Soldering Parameters



Profile Feature	Pb-Free Assembly
Average ramp-up rate ( $T_L$ to $T_P$ )	3°C/second max.
Preheat -Temperature Min ( $T_{S\ min}$ ) -Temperature Max ( $T_{S\ max}$ ) -Time (min to max) ( $t_s$ )	150°C 200°C 60-180 seconds
$T_{S\ max}$ to $T_L$ -Ramp-up Rate	3°C/second max.
Time maintained above: -Temperature ( $T_L$ ) -Time ( $t_L$ )	217°C 60-150 seconds
Peak Temperature ( $T_P$ )	260°C
Time within 5°C of actual Peak Temperature ( $t_p$ )	20-40 seconds
Ramp-down Rate	6°C/second max.
Time 25°C to Peak Temperature	8 minutes max.

### Part Number Code and Marking Code

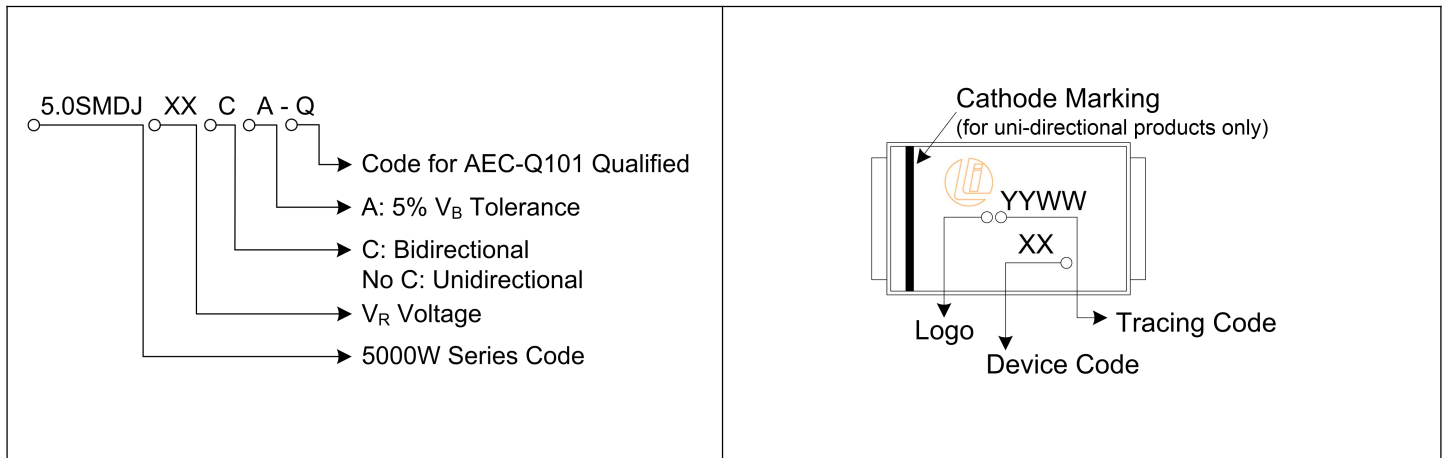

### Dimensions (SMC/DO-214AB)

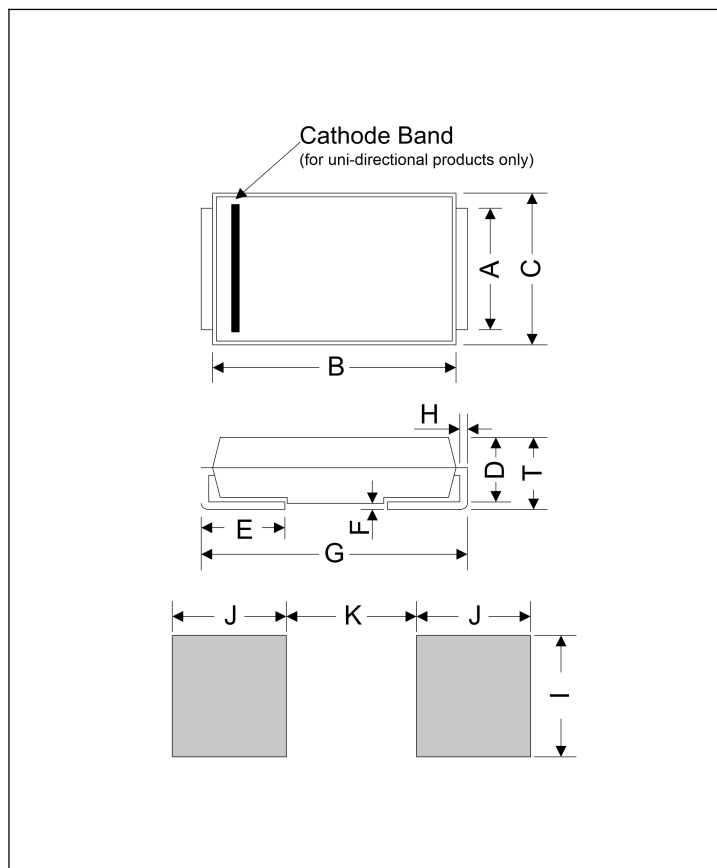

Symbol	Millimeters		Inches	
	Min.	Max.	Min.	Max.
A	2.900	3.200	0.114	0.126
B	6.600	7.110	0.260	0.280
C	5.590	6.220	0.220	0.245
D	2.060	2.620	0.079	0.103
E	0.760	1.520	0.030	0.060
F	-	0.203	-	0.008
G	7.750	8.130	0.305	0.320
H	0.152	0.305	0.006	0.012
T	2.200	2.750	0.087	0.108
I	3.300	-	0.129	-
J	2.400	-	0.094	-
K	-	4.200	-	0.165

## Packaging Specification

### Tape

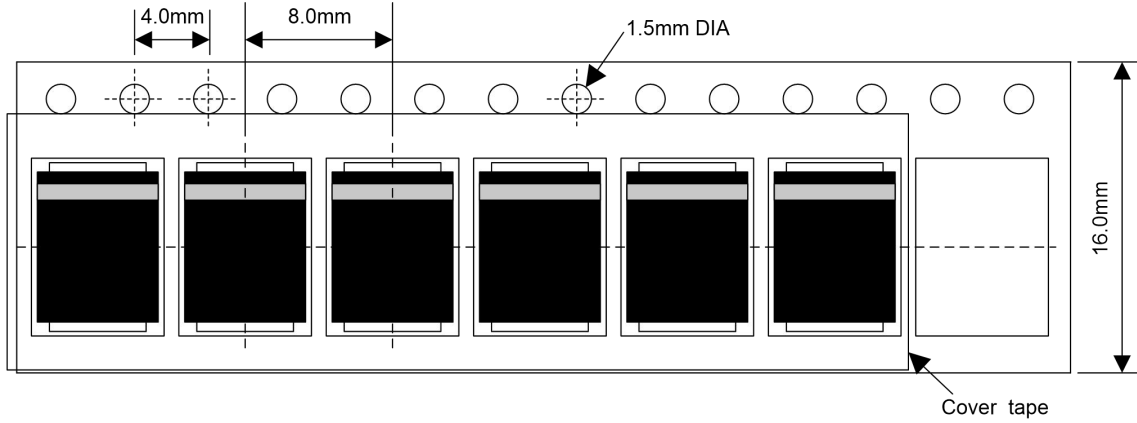

### For Uni-Devices

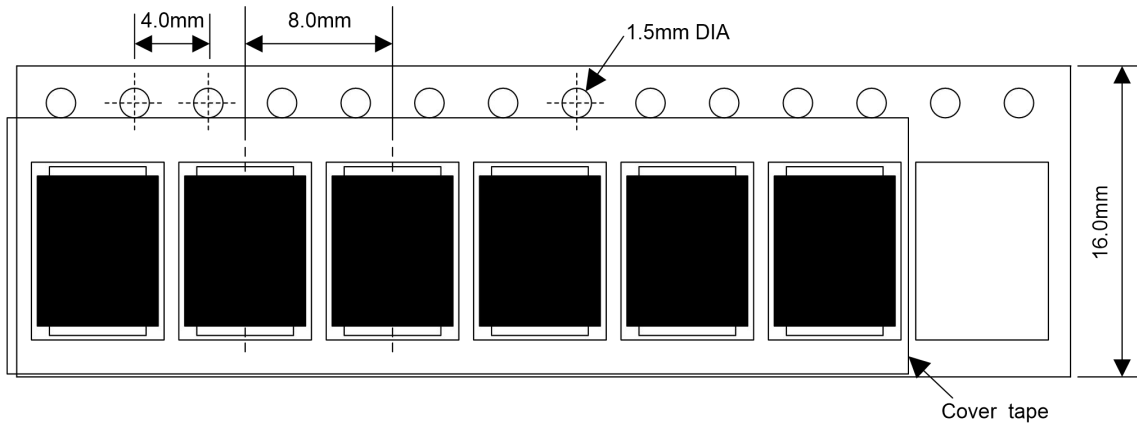

### 13 Inches Reel

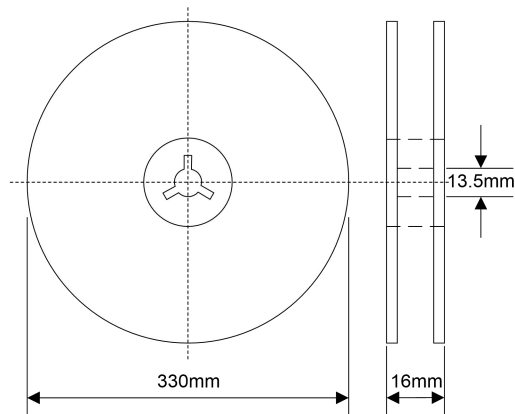

Quantity: 3000pcs/reel